



INSTALLATION, OPERATION & MAINTENANCE INSTRUCTIONS

1455 Kleppe Lane ♦ Sparks, NV 89431-6467 ♦ (775) 359-4712 ♦ Fax (775) 359-7424

E-mail: haws@hawsco.com ♦ website: www.hawsco.com

Distributed by Haws - EMEA P: + 41(0)34 420 60 00 website: www.Haws.ch

No. 0002080089 Rev 5

Model 9321/9321CE/9326/9326CE/9327/9327CE **Instantaneous Tankless Water Heater**

NOTE TO INSTALLER: Please leave this information with the Maintenance Department.



9326/9327 SHOWN



9321 SHOWN

**SHOULD YOU EXPERIENCE DIFFICULTY WITH THE INSTALLATION OF THIS
MODEL PLEASE CALL:**

TECHNICAL SUPPORT: + 1-800-766-5612

FOR CUSTOMER SERVICE: + 1-888-640-4297

HAWS-EMEA CONTACT P: + 41(0)34 420 60 00

SAFETY



DANGER!

Indicates an imminently hazardous situation which, **if not avoided, will result in death or serious injury.**



WARNING!

Indicates a potentially hazardous situation which, **if not avoided, could result in death or serious injury.**



CAUTION!

Indicates a potentially hazardous situation which, **if not avoided, may result in minor or moderate injury.**

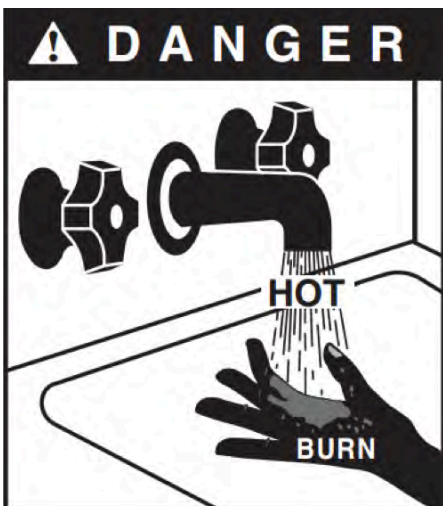
	<p>Hot water can be dangerous. There is a high scald potential if the thermostat is set too high.</p> <p>Water temperatures over 125 °F (51 °C) can cause severe burns or scalding resulting in death.</p> <p>Hot water can cause first degree burns with exposure for as little as:</p> <ul style="list-style-type: none">3 seconds at 140 °F (60 °C)20 seconds at 130 °F (54 °C)8 minutes at 120 °F (48 °C)
---	---



IMPORTANT SAFETY INFORMATION

READ ALL INSTRUCTIONS BEFORE USING

1. You must read and follow all instructions. Serious bodily injury or death could occur if you ignore this warning.
2. All circuit breakers and/or disconnect switches servicing the heater must be turned off when installing, uninstalling, or repairing this water heater.
3. The unit must be installed by a licensed electrician and plumber.
4. The unit must be wired in accordance with the current version of the National Electrical Code (US), Canadian Electric Code (Canada) or IEC International Standards.
5. This installation must comply with all national, state, and local plumbing and electrical codes.
6. When the heater is not within sight of the electrical circuit breakers, an additional local means of disconnection of all ungrounded conductors must be provided that is within sight of the appliance or a circuit breaker lockout must be used. (Ref. NEC 422.31)
7. Per UL 499, this water heater is not required to be installed with a Temperature and Pressure relief valve (T&P). However, local codes may vary. In case a T&P relief valve is required, it must be installed on the outlet hot water line heater between the heater and the isolation valve.
8. If the Haws tankless water heater is installed in a location where water damage could occur in the event of a leak, it is recommended that a drip pan be installed and connected to a suitable drain. Alternatively, an active water leak detector and shut off valve can be installed to turn off your water supply in the event a leak is detected.
9. If water supply has a high mineral content, a water softening system is recommended. Damage to the water heater resulting from scale or hard minerals will not be covered under warranty.
10. When the heater is installed in a well water system or if the plumbing system is prone to introducing air into the heater, it is highly recommended that an air separator be installed in the cold water feed to the heater to avoid possible failure of the heating element and/or heating chamber.
11. In accordance with NEC guideline, this water heater is designed for a continuous duty cycle of 3 hours at 100% power output. Exceeding this rating could damage the heater and void the warranty.
12. Provide your heater with potable, uninterrupted supply of water at a constant minimum pressure of 35 PSI (2.4 bar) (based on model) and maximum pressure of 150 PSI (10.3 bar).
13. Use of Water Hammer Arrestors in applications required; neglecting to do so will damage the heater and void the warranty.
14. This heater must be in a location where it is not subject to freezing temperatures unless supplied with factory installed freeze protection.
15. Properly purge air out of system before power is applied. Recommended to purge water through system for minimum 2 minutes at a minimum 15 gpm (57 lpm), closing and opening drain valve 3 times to move any lodged air before power is applied.
16. This appliance is not intended for use by persons unless they're certified personnel or have been given proper instruction and supervision.
17. This appliance cannot be played with by children. Install to prevent children from playing with or around the appliance.
18. Cleaning and user maintenance should only be performed by trained and licensed professionals.
19. Sanitation models used in a circulator system, a 30 second factory set delay program will be installed to establish flow before power is applied. **Contact Haws for information at +1-800-766-5612 or Haws - EMEA at P: + 41(0)34 420 60 00**
20. Applications with the use of a recirculation circulator must be installed according schematics.
21. **The use of Ethylene glycol antifreeze is strictly prohibited. Propylene Glycol is the only recommended antifreeze.**

TABLE OF CONTENTS

PERFORMANCE FEATURES	4
MOUNTING THE HEATER TO THE WALL	6
ELECTRICAL SPECIFICATIONS	8
PLUMBING HOOKUP	9
COMMISSIONING THE WATER HEATER	11
MONITORING & PREVENTIVE MAINTENANCE	15
CONTROL FEATURES	16
TROUBLESHOOTING PROCEDURES	18
TECHNICAL SUPPORT	19
REPAIRS AND OPTIONS	22
WIRING SCHEMATICS	27
LIMITED WARRANTY INFORMATION	30

PERFORMANCE FEATURES

Heating Technology	» Field Replaceable, non-ferrous, lead-free cartridge-style direct heating element
Safety and Reliability	» Thermo-Optical sensor for protection against entrained air or improper commissioning
Materials and Construction	» NSF-61 listed materials of construction
Control and Consumption	» Active energy management to ensure optimal application of energy based on real-time system demands » Multistage element turn-on » Visual user interface for field programming
Turn-on Flow Rate	» Integrated high-capacity flow meter » Field adjustable maximum activation flow rate (minimum activation flow rate factory set and is not field adjustable.)
Pressure Rating	» Operating pressure range not to exceed 60 – 90 PSI (4.1 – 6.2 bar). Maximum pressure rating 150 psi (10.3 bar)
Available Enclosures	» Standard Cabinet (Non-Waterproof) » N4 – NEMA 4 (Standard) » N4X – NEMA 4X 304SS » N4X6 – NEMA 4X 316SS
Class I Div II enclosures Optional Features for NEMA 4 and 4X Applications	» Indoor disconnect switch (fused or non-fused) » Stand Kits (for freestanding applications) » Alarm contacts » GFCI » Freeze Protection » Remote Display

PERFORMANCE FEATURES

How the Haws Tankless Water Heater Works

Operating the new Haws tankless water heater is similar to using any traditional water heater system. However, it is very important that all of the set-up procedures and operating instructions are carefully read to ensure maximum performance and energy savings from the water heater.

The Haws tankless water heater does not store hot water like a conventional tank-type water heater. It contains high powered bare wire technology heating elements that are capable of heating water instantly on-demand. Whenever there is a hot water demand, the patented flow meter within the heater recognizes the demand and initiates the heating process. This meter measures the water flow rate while two thermistor sensors measure the incoming and outgoing water temperature. This information is transmitted continually to the microprocessor controller which determines the precise amount of power to send to the heating elements to heat the water to the desired temperature. The Haws tankless water heater only uses as much power as is needed to meet the demand by fully modulating the heating elements from 0 to 100%.

It is important to keep in mind that all tankless water heaters are subject to a maximum flow rate. If this flow rate is exceeded, the heater will not be capable of fully heating water. The amount of water that can be heated by the tankless water heater at any given time will depend on the model selected and the incoming water temperature. See diagram on below to determine the maximum flow rates. Since a tankless water heater eliminates the ongoing thermal losses caused by storing hot water in a tank, there will be a significant energy savings compared to a conventional tank type water heater.

Eye/Face Wash & Drench Showers

Voltage	kW Rating	Temperature rise in GPM (° F) Temperature rise in LPM (° C)								
		Emergency Eyewash applications				Emergency Eye, Face, and Drench applications				
		3 GPM 11 LPM	4 GPM 15 LPM	5 GPM 19 LPM	6 GPM 23 LPM	20 GPM 76 LPM	23 GPM 87 LPM	26 GPM 98 LPM	30 GPM 114 LPM	40 GPM 151 LPM
208	54	123° F 68° C	92° F 51° C	74° F 41° C	61° F 34° C	18° F 10° C	16° F 9° C	14° F 8° C	12° F 7° C	9° F 5° C
400	50	114° F 63° C	85° F 47° C	68° F 38° C	57° F 32° C	17° F 9° C	15° F 8° C	13° F 7° C	11° F 6° C	9° F 5° C
400	75	•	128° F 71° C	102° F 57° C	85° F 47° C	26° F 14° C	22° F 12° C	20° F 11° C	17° F 9° C	13° F 7° C
400	100	•	•	136° F 76° C	114° F 63° C	34° F 19° C	30° F 16° C	26° F 15° C	23° F 13° C	17° F 9° C
400	120	•	•	•	136° F 76° C	41° F 23° C	36° F 20° C	32° F 18° C	27° F 15° C	21° F 12° C
480	54	123° F 68° C	92° F 51° C	61° F 34° C	49° F 27° C	18° F 10° C	16° F 9° C	14° F 8° C	12° F 7° C	9° F 5° C
480	72	•	123° F 68° C	82° F 46° C	66° F 37° C	25° F 14° C	21° F 12° C	19° F 11° C	16° F 9° C	12° F 7° C
480	108	•	•	123° F 68° C	98° F 54° C	37° F 21° C	32° F 18° C	28° F 16° C	25° F 14° C	18° F 10° C
480	126	•	•	•	115° F 64° C	43° F 24° C	37° F 21° C	33° F 18° C	29° F 16° C	22° F 12° C
600	61	139° F 77° C	104° F 58° C	83° F 46° C	69° F 38° C	21° F 12° C	18° F 10° C	16° F 9° C	14° F 8° C	10° F 6° C
600	102	•	•	139° F 77° C	116° F 64° C	35° F 19° C	30° F 17° C	27° F 15° C	23° F 13° C	17° F 9° C
600	130	•	•	•	118° F 66° C	44° F 24° C	39° F 22° C	34° F 19° C	26° F 14° C	22° F 12° C
600	150	•	•	•	•	51° F 28° C	45° F 25° C	39° F 22° C	34° F 19° C	26° F 14° C

• Temperature electronically limited to factory preset not exceed temperature.

MOUNTING THE HEATER TO THE WALL

Please follow the mounting instructions as appropriate to your installation. Haws recommends the heater be installed close to the point of use.



CAUTION

This heater must be installed in a location where it is not subject to freezing temperatures, unless supplied with factory installed freeze protection

Make sure the brass fittings are at the bottom of the heater. No other heater orientation is permitted.

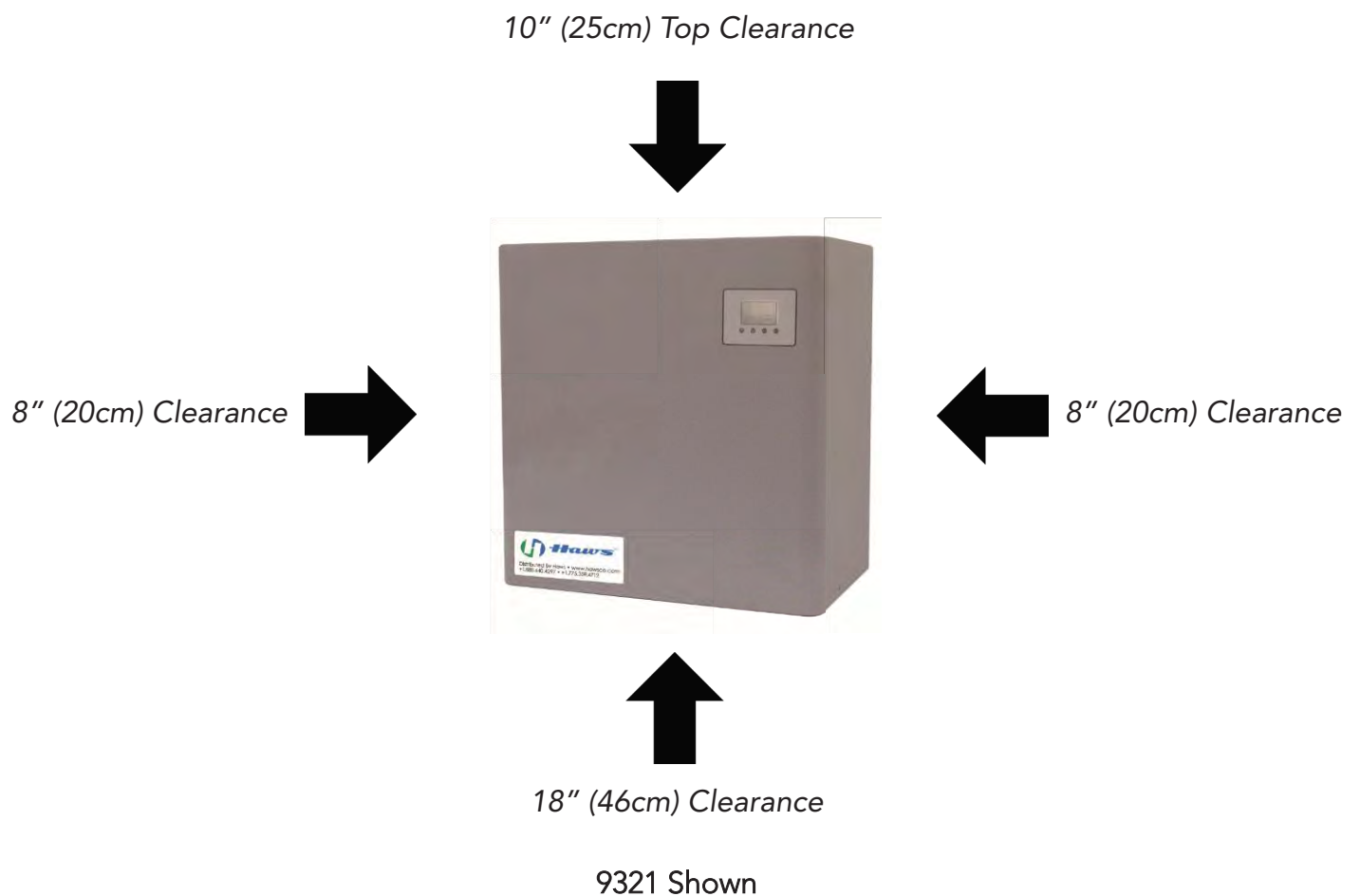

The 9321/9321CE/9326/9326CE/9327/9327CE series is approved for zero clearance to combustibles. Above clearances recommended for service and installation.

Haws recommends your heater be installed or serviced by a licensed plumber and electrician.



WARNING

Before beginning any work on this installation, BE SURE THAT THE ELECTRICAL BREAKER IS "OFF" AND THAT ALL MOUNTING AND PLUMBING WORK HAS BEEN COMPLETED PER THESE INSTRUCTIONS.

This heater must have its own independent circuit using insulated, UL listed wire conductors of the appropriate size suitable for up to 90° C (194° F) and protected by the correctly rated circuit breaker.

See chart on next page.



Before starting any electrical work VERIFY there is no power at the heater before proceeding.

The power conductors are to be secured to the L1, L2 and L3 connectors on the terminal block (**Fig. 1**) or contactor (**Fig. 2**). The ground is to be secured to the GND connector to the right of the terminal block.

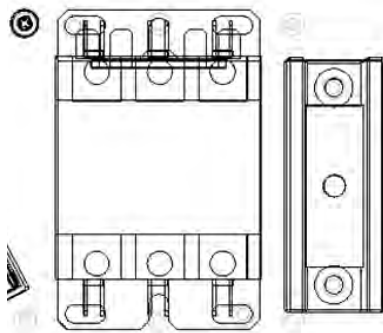

Fig. 1

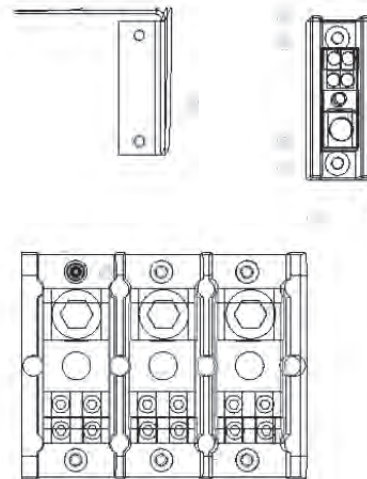

Fig. 2



WARNING

FAILURE TO GROUND THE SYSTEM MAY RESULT IN SERIOUS INJURY, DEATH AND/OR PROPERTY DAMAGE.

ELECTRICAL SPECIFICATIONS

Eye/Face Wash & Drench Showers

VOLTAGE (DELTA)	POWER (KW)	AMPS	RECOMMENDED WIRE SIZE	TURN-ON (GPM/LPM)	PHASE	NPT FITTING
208v 3Ø	54	150A/phase	1/0 AWG	1.5 5.67	THREE	1.25"
400v 3Ø	50	73A/phase	4 AWG	1.5 5.67	THREE	1.25"
400v 3Ø	75	109A/phase	2 AWG	2.5 9.46	THREE	1.25"
400v 3Ø	100	145A/phase	1/0 AWG	2.5 9.46	THREE	1.25"
400v 3Ø	120	174A/phase	2/0 AWG	2.5 9.46	THREE	1.25"
480v 3Ø	54	65A/phase	4 AWG	1.5 5.67	THREE	1.25"
480v 3Ø	72	87A/phase	3 AWG	2.5 9.46	THREE	1.25"
480v 3Ø	108	130A/phase	1 AWG	2.5 9.46	THREE	1.25"
480v 3Ø	126	151A/phase	2/0 AWG	2.5 9.46	THREE	1.25"
600v 3Ø	61	59A/phase	6 AWG	2.5 9.46	THREE	1.25"
600v 3Ø	102	98A/phase	3 AWG	2.5 9.46	THREE	1.25"
600v 3Ø	130	125A/phase	1 AWG	2.5 9.46	THREE	1.25"
600v 3Ø	150	144A/phase	1/0 AWG	2.5 9.46	THREE	1.25"

A green terminal (or a wire connector marked "G", "GR, "Ground", or "GROUNDING") is provided within the control box. To reduce the risk of electric shock, connect this terminal or connector to the grounding terminal of the electric service or supply panel with a continuous copper wire in accordance with your local electrical code.

PLUMBING HOOKUP



MUST FLUSH LINE A MINIMUM 5 MINUTES, AT A MINIMUM 15 GPM (57 LPM) ON INITIAL STARTUP

The heater is equipped with NPT brass fittings.

Make sure **ONLY** NPT fittings are used for connection to this heater.

Connect the cold water line with the inlet connection (**RIGHT** fitting).

Connect the outlet pipe with the outlet fitting (**LEFT** fitting).

Do not reverse connections.

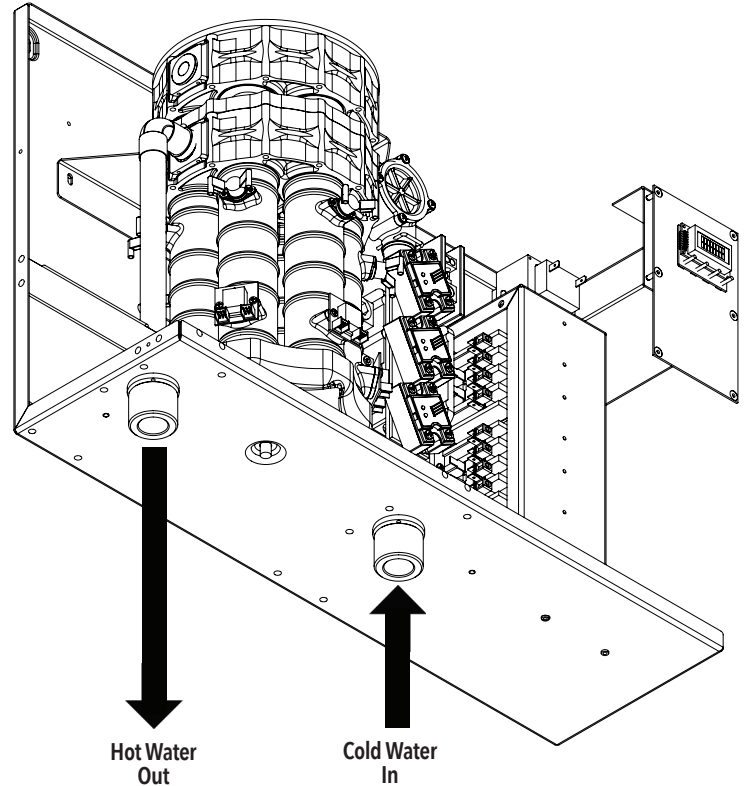

CAUTION

Never use pipe dope when making plumbing connections to this heater. Follow standard industry practice with careful application of Teflon tape. **Do not** allow Teflon tape to get into the heater.



CAUTION

Never solder any pipe connections while attached to this heater – damage to the heater will result. Doing this will **void the warranty**.

PRV VENT LOCATION

The PRV Vent is not a code compliant pressure relief valve. Check local codes to see if a code compliant Temperature and Pressure relief valve is required in your installation.





WARNING

- ⚠ MUST FLUSH OUT WATER HEATER FOR MINIMUM 5 MINUTES AT A MINIMUM 15 GPM (57 LPM) ON INITIAL START UP OR AFTER ANY SERVICE WORK HAS BEEN PERFORMED.**
- ⚠ CLOSE AND OPEN DRAIN VALVE 3 TIMES TO REMOVE ANY LODGED AIR BUBBLES. FAILURE TO DO SO MAY DAMAGE THE HEATER.**
- ⚠ MINIMUM INLET WATER PRESSURE 35 PSI (2.4 BAR) DYNAMIC.**
- ⚠ MAXIMUM WATER PRESSURE NOT TO EXCEED 150 PSI (10 BAR). RECOMMENDED OPERATING PRESSURE 60 – 90 PSI (4.1 – 6.2 BAR).**
- ⚠ USE OF A PRESSURE REGULATOR RECOMMENDED.**
- ⚠ THE USE OF DI-ELECTRIC UNIONS MUST BE USED ON THE INLET AND OUTLET PORTS OF THE WATER HEATER. IF HEATER IS TO BE USED IN A RECIRCULATORY LOOP, A 40 MESH (1/64" / 0.4MM OR SMALLER) Y-STRAINER MUST BE INSTALLED IN COLD WATER INLET TO PREVENT DEBRIS FROM ENTERING THE WATER CHAMBERS.**
- ⚠ WATER SUPPLY INLET PIPING MUST BE A MINIMUM 1 ¼" (3.175 cm) PIPE DIAMETER AND IT MUST BE A DEDICATED SUPPLY LINE. 2 ½" (6.35 cm) MINIMUM PIPE DIAMETER ON TRUNK MAIN WHEN PART OF A BRANCH SYSTEM.**
- ⚠ BLOCKAGE CAUSED BY DEBRIS MAY CAUSE ELEMENT FAILURE. ISOLATION VALVES RECOMMENDED FOR SERVICING.**
- ⚠ IN APPLICATIONS WHERE A LONG DUTY CYCLE IS NEEDED (MORE THAN 3 HOURS CONTINUOUS RUN TIME), OR A SHORT DUTY CYCLE (LESS THAN 30 SEC. ON TIME WITH LESS THAN MINUTE OFF TIME) PLEASE CONTACT HAWS TECHNICAL SUPPORT AT +1-800-766-5612 OR HAWS - EMEA P: +41(0)34 420 60 00**
- ⚠ HAMMER ARRESTOR: SYSTEMS WITH A LARGE WATER VOLUME, OR LONG LENGTHS OF PIPING, CAN BE SUSCEPTIBLE TO WATER HAMMER. THE USE OF SLOW ACTING VALVES ALONG WITH THE INSTALLATION OF A WATER HAMMER ARRESTOR IS HIGHLY RECOMMENDED ON ALL UNITS. FAILURE TO INSTALL A WATER HAMMER ARRESTOR CAN CAUSE DAMAGE TO WATER HEATER AND VOID WARRANTY. REFER TO MANUFACTURER'S INSTALLATION MANUAL FOR PROPER SIZE AND INSTALLATION LOCATION.**

Proper water conditions must be maintained to prevent damage to the water heater.

CONSTITUENT (mg / L)	MAXIMUM ALLOWABLE	BETTER	BEST
Alkalinity	50	25	10
Calcium	2.5	5	0.5
Carbon Dioxide	0	0	0
Chlorine	100	15	1
Free Chlorine	1	1	0.05
Iron	0.2	0.1	0.01
Magnesium as Mg	0.5	0.1	0.1
Magnesium as Mn	0.1	0.1	10
Nitrate	25	25	10
Oxygen	2	1	0.1
Silica	15	10	1
Sodium	50	10	1
Sulfate	25	25	1
TDS	200	100	5**
Total Hardness (Grains per Gallon)	25	10	1
Total Hardness (Grains per Liter)	114	45	4.5
pH	6.5-8.5	6.5-8.5	6.5-8.5
Turbidity (NTU)	5	5	1

* NOTE: Total dissolved solids

** NOTE: Do not reduce the TDS beyond this amount or the water will be too aggressive

COMMISSIONING THE WATER HEATER



CAUTION

BEFORE SWITCHING THE ELECTRICAL BREAKER "ON", MAKE SURE THE INLET AND OUTLET BALL VALVES ARE FULLY OPEN AND WATER IS FLOWING THROUGH ALL POINTS OF USE FOR A **MINIMUM OF 5 MINUTES AT A MINIMUM 15 GPM (57 LPM)**. **Open and close drain valve 3 times while purging to remove any lodged air bubbles.** DO NOT SWITCH THE BREAKER "ON" IF THERE IS ANY POSSIBILITY THE WATER IN THE HEATER IS FROZEN.



After verifying the heater has been purged of air (see above) turn the circuit breaker/disconnect "**ON**" and observe the start-up sequence on the display. The LCD screen will display the **SETPOINT TEMPERATURE** in degrees F or degrees C.

Below the display are 4 push buttons that are used to control the function of the heater. Press the **UP** or **DOWN** buttons to establish your desired temperature. Refer to the **CONTROL FEATURES** section of this manual for additional information.



Startup Process

Plumbing Installation Checklist **MUST BE FILLED OUT AND LEFT WITH WATER HEATER. MUST FLUSH WATER HEATER FOR MINIMUM 5 MINUTES.**



IMPORTANT

Read and fully understand all steps outlined below before proceeding. Failure to do so may damage the water heater and void any warranty. Haws Technical support is available at + 1-800-766-5612 or Haws - EMEA P: + 41(0)34 420 60 00



PLUMBING INSTALLATION CHECKLIST

STEP	CATEGORY	ACTION	CONFIRMED BY	NOTES
1	Water	Heater is supplied with clean potable water		
2	Water	Plumbing orientation is correct - water connections on the bottom - inlet on the right, outlet on the left		
3	Water	Ensure piping connections are not causing stress or torque on the inlet and outlet fittings		
4	Water	No leaks at water connection or in plumbing network		
5	Water	Water pressure is between 60-90 PSI (min. 35 psi) (4.1-6.2 bar (min. 2.4 bar))		
6	Water	Long pipe runs, high flow rates and valves closing can cause pressure spikes (water hammer) above 1000 PSI (68.9 bar) Consult piping schematic to ensure arrestors and regulators are properly sized and located.		
7	Water	(with power off) Open supply valves to water heater - run water through fixtures to purge all air and debris in system. With water flowing, visually inspect the clear element tubes between the inlet and outlet manifold to ensure no air bubbles are present. (this may take several minutes)		
8	Water	Using a flashlight, visually inspect heating chamber for any signs of leakage		
9	Water	Ensure Water Heater will not freeze		
10	Water	Ensure all local plumbing codes are met		
11	Water	Plumbing installation correct and complete		



IMPORTANT

Read and fully understand all steps outlined below before proceeding. Failure to do so may damage the water heater and void any warranty. Haws Technical support is available at + 1-800-766-5612 or Haws - EMEA P: + 41(0)34 420 60 00



ELECTRICAL INSTALLATION CHECKLIST

STEP	CATEGORY	ACTION	CONFIRMED BY	NOTES
12	Power	(with power off) - Breaker and disconnect are of proper size and correctly installed		
13	Power	(with power off) - Wiring and conduit are of proper size and correctly installed		
14	Power	(with power off) - Wiring connections at terminals are correct orientation, tight, with no stray wire strands or pinched sheathing		
15	Power	(with power off) - Proper ground (not neutral) is clean, and tight		
16	Power	(no water flowing, do not turn it on, close outlet water shut off valve if uncontrolled environment-left hand side) Apply power - ensure voltage and phasing is according to model rating		
17	Power	Disengage power after voltage and phasing is confirmed (open outlet shutoff valve if closed during step 16)		
18	Power	Ensure all local electrical codes are met		
19	Power	Electrical Installation correct and complete		



STARTUP PROCEDURE AND CHECKLIST

STEP	CATEGORY	ACTION	CONFIRMED BY	NOTES
20	Startup	Water requirements (Steps 1-11) are confirmed		
21	Startup	Electrical requirements (Steps 12-19) are confirmed		
22	Startup	Plumbing Codes and Electrical Codes are met and confirmed		
23	Startup	(with power off) Open supply valves to water heater - run water through fixtures to purge all air and debris in system. With water flowing, visually inspect the clear element tubes between the inlet and outlet manifold to ensure no air bubbles are present. (this may take several minutes) Chugging or burping of water is also an indication of air		
24	Startup	Turn off water flow at all fixtures, keeping water heater supply valves open		
25	Startup	Apply power to water heater		
26	Startup	Turn water flow on at fixtures		
27	Startup	LCD display board is illuminated		
28	Startup	Contactors engaged (audible click)		
29	Startup	No error codes		
30	Startup	Scroll through display (If display is locked, consult manual for unlock procedure)		
31	Startup	Adjust settings if needed. Note - Keep temperature setting as low as possible for scald potential and minimizing abuse on the heater		
32	Startup	Confirm TURN-ON setting meets fixture flow rate		
33	Startup	Confirm SETPOINT setting on display		
34	Startup	Confirm ACTUALTEMP output on display		
35	Startup	If SETPOINT does not match ACTUALTEMP then use the TEMPERATURE RISE CHART in manual along with LOAD%, INLET TEMP and FLOW RATE on display to determine the maximum theoretical output		
36	Startup	Shut water flow off at fixture		
37	Startup	Power disengaged (audible)		
38	Startup	Repeat startup steps 25-28 to ensure proper activation and performance		
39	Startup	Water heater installed correctly and operating as designed		



SHUT DOWN PROCEDURE (Normal, Emergency, and Long Term)

STEP	CATEGORY	ACTION	CONFIRMED BY	NOTES
NORMAL SHUT DOWN PROCEDURE				
1	Normal	Shut power off to unit in order of sequence - In-door (on-door) disconnect (if applicable), local disconnect, main breaker - perform lock out procedure per facilities requirements		
2	Normal	Close applicable water valves - Inlet and outlet (water heater will not be drained)		
EMERGENCY SHUT DOWN PROCEDURE				
1	Emergency	Shut power off to unit In-door (on door) disconnect (if applicable) or local disconnect		
2	Emergency	Shut water valves off - inlet and outlet (water heater will not be drained)		
3	Emergency	Complete lock out procedures per facilities requirements		
4	Emergency	Notify all parties involved that water heaters are shut down		
LONG TERM SHUT DOWN PROCEDURE				
1	Long-Term	Shut power off to unit in order of sequence - In-door (on-door) disconnect (if applicable), local disconnect, main breaker - perform lock out procedure per facilities requirements		
2	Long-Term	Close applicable water valves - Inlet and outlet		
3	Long-Term	Drain water heater through plumbing network, run compressed air through the water heater to ensure the heater is completely drained		
4	Long-Term	Lock out all applicable water valves per facilities procedures		

MONITORING & PREVENTIVE MAINTENANCE

RECOMMENDED ROUTINE INSTRUMENT READINGS AND OPERATION CHECKING:

Please note the instrument readings are performed during water heater operation. No readings are required when the unit is not being used. Check the following readings on the Remote display and ensure proper performance:

- Inlet temperature
- Temperature set point
- Actual outlet temperature
- Actual GPM / LPM
- Error codes

EARLY WARNING SIGNS OF DEVELOPING OPERATIONAL OR EQUIPMENT PROBLEMS:

- Based in the readings from the Startup Procedure on page 13, water heater unit appears to be performing properly, however there are error codes
- Actual flow rate appears to be lower than desired

PROCEDURES FOR HANDLING NON-ROUTINE PROBLEMS SUCH AS ALARMS, POWER FAILURE, AND COMPONENT FAILURE:

- Power failure will result in a non-operable system – restore power and startup unit per Startup Process on page 13
- Component failure will result in repeat error codes. Refer to manual page 18 for error codes and corrective action

PREVENTATIVE MAINTENANCE REQUIREMENTS:

(PMR) Preventive maintenance requirements may impact other items of the installation such as electrical supply and wiring, water piping and associated valves and controls. Haws water heaters are very low maintenance.

Ensure that the water heater is supplied with a clean potable, consistent water supply as outlined in the Installation, Operation, and Maintenance Manual.

Check filter screen or associated y-strainer or other pre-filters to ensure clear water supply within listed water pressure. Ensure proper electrical supply as outlined within the Installation, Operation, and Maintenance Manual.

PMR per site requirements, not to exceed 90 days.

MAINTENANCE INSPECTION PROGRAM:

(MIP) Haws water heaters are very low maintenance. Ensure PMR is completed every 90 days.

Disable power to the unit via external disconnect or local disconnects. Per site lockout procedures open cabinet door and visually inspect components for signs of damage associated with possible water leaks, excessive heat or external factors that could impact the water heater and associated components.

CONTROL FEATURES



CAUTION

BEFORE USING THIS CONTROL, make sure all prior installation steps have been properly completed, electrical power is on and water is present in the heater.

PUSH BUTTON FLOW CHART

- 1) The **SETPOINT TEMP** or **ACTUAL TEMP** screen can be selected for display as the home screen. Either of these screens will remain on the display when the backlight timer expires.



- 2) There is a 5-minute time delay built into the control. Regardless of which screen is being displayed, after 5 minutes of inactivity, the display will revert to the **SETPOINT TEMP** screen.



- 3) The 4 push buttons are used to control the operation of the heater. The **LEFT** and **RIGHT** buttons shift the display from one screen to another. The **DOWN** and **UP** buttons may change the values within selected screens.



- 4) As an example, when the screen displays **SETPOINT TEMP**, the desired hot water temperature will increase 1 degree for each press of the **UP** button and decrease 1 degree for each press of the **DOWN** button. Note that minimum and maximum set point temperatures are established at the factory.



- 5) The **LEFT** and **RIGHT** buttons shift the display from one screen to another. From the **INLET TEMP** screen, one press of the **RIGHT** button will shift the display to the **SETPOINT TEMP** screen. **INLET TEMP** shows the actual temperature of the water entering the heater.



- 6) From the **SETPOINT TEMP** screen, one press of the **RIGHT** button will shift the display to the **ACTUAL TEMP** screen. This shows the actual temperature of the water leaving the heater.



- 7) From the **ACTUAL TEMP** screen, one press of the **RIGHT** button will shift the display to the **LOAD PCT** screen. This shows the electrical power consumption as a percentage of full power.



- 8) From the **LOAD PCT** screen, one press of the **RIGHT** button will shift the display to the **FLOWRATE** screen. This shows the rate of flow of water through the heater.



- 9) From the **FLOWRATE** screen, one press of the **RIGHT** button will shift the display to the **UNITS** screen. This shows the units of measure in either the **ENGLISH** or **METRIC** systems. **ENGLISH** units are degrees Fahrenheit and gallons per minute. **METRIC** units are degrees Celsius and liters per minute. Use the **UP** and **DOWN** buttons to select the desired units of measure.



- 10) From the **UNITS** screen, one press of the **RIGHT** button will shift the display to the **SOFTWARE VERSION** screen. This shows the version level of the software in the control.



- 11) From the **SOFTWARE VERSION SCREEN**, one press of the right button will shift the display to the **ERRORS** screen. This shows the error history of the heater. "0 ERRORS" means that no errors have occurred.



If the heater has an error history of 4 errors: this history will be displayed on the screen as shown. "CODE 1:E0" refers to the first error and indicates it to be an **E0** error. One press of the **UP** button will show the second error as "CODE 2:E0" error.

Continued pressing of the **UP** or **DOWN** buttons will scroll through each of the errors in the history (in this case a total of 4). **ERRORS** indicate an undesirable condition but will not shut down the operation of the heater.



CAUTION

Keep the INLET BALL VALVE fully "OPEN". NEVER RESTRICT THE WATER FLOW USING THE INLET VALVE.

ERROR CODES

E0: Excessive water flow detected

Corrective action: Using the OUTLET BALL VALVE, slowly reduce water flow until the desired temperature is achieved. The temperature is proportional to the flow through the heater; the lower the flow, the higher the temperature and vice versa.

- 01** FAULTS are communicated through the LCD display. The display will switch from the SETPOINT screen to the FAULT screen and back again every 3 seconds. FAULTS indicate an undesirable condition and will immediately shut down the operation of the heater. If faults are appearing on your heater call Haws Technical Support for assistance at +1-800-766-5612 or Haws - EMEA call P: + 41(0)34 420 60 00.

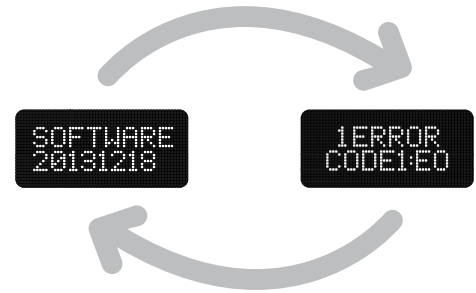

FAULT CODES

E0: Excessive water flow detected

F1: No change in water temperature detected

F2: Dry fire detected - Optical Sensor Tripped

F3: Excessive dry fire occurrences detected

F4: Inlet thermistor out of range

- 13)** The security of the heater settings is provided by pressing and holding the LEFT and UP buttons for 3 seconds to lock the buttons. Once locked, the buttons have no function. Press and hold the same LEFT and UP buttons for 3 seconds to unlock the buttons.

The security status can be checked at any time by pressing any one button. If the system is locked, the screen will display "BUTTONS LOCKED".

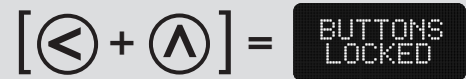

- 14)** The display can be turned off or on. Press and hold the DOWN and RIGHT buttons for 3 seconds. If the display is off, it can be turned on by pressing and holding the same DOWN and RIGHT buttons for 3 seconds.

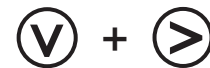

TROUBLESHOOTING PROCEDURES

If you need any assistance from our Technical Service Department, make sure you can identify this water heater by having the model number and serial number.

Model No. _____

Serial No. _____

Call +1-800-766-5612
 communications@hawsco.com or
 Haws-EMEA Call P: + 41(0)34 420 60 00
 www.Haws.ch

PROBLEM	POSSIBLE CAUSES	ACTION	IF TRUE PROCEED TO ACTION	IF FALSE PROCEED TO ACTION	
Unit does not power on	Main Power issue	A1	Check main power supply voltage is within +/- 5% of nominal. Check breaker and wire size	A2	Provide the correct supply voltage to the heater
	Blown Fuse	A2	Check all fuses for continuity	A3	Check voltages and elements, replace fuse
	Transformer overload	A3	Check circuit breaker on 24V control transformer	A4	Check voltages and for failed PCB, Contactors- reset transformer
	Printed circuit board (PCB)	A4	Verify main PCB is plugged in at P16	Replace PCB	Check connection, and reset connector
Display ERROR E1	Water temperature entering heater is above SETPOINT	A5	Verify supply water supply temperature is below set point. <i>Note - Heater will automatically engage when incoming water drops below set point.</i>	A6	Adjust supply temperature below set point
	Loose PCB connection or pinched wire	A6	Check PCB connection at P7 and check wire routing	A7	Check connection, and reset connector
	Inlet thermistor failure	A7	Check thermistor for proper placement in well	Replace thermistor	Re-seat thermistor in well
Display FAULT F0	Outlet thermistor out of range	A8	Check PCB connection at P7 and check wire routing	A9	Check connection, and reset connector
	Outlet thermistor is damaged, or wire is cut	A9	Check thermistor, wire, or connector for damage	Replace thermistor	A10
	Heater is frozen	A10	Verify supply and feed lines are not frozen	Un-freeze heater and check functionality	
Display FAULT F1	No change in water temperature detected	A11	Verify change in temperature by checking ACTUAL TEMP vs INLET TEMP	Lower flow rate to allow heater to operate in range of capability	A12
	Thermistor failure	A12	Follow actions A5-A7		A13
	Thermal trip at ECO/ Damaged wire	A13	Power off, Using a multimeter check continuity at PCB P17 pins 1 and 3. Check all wires for loose connection	A14	No continuity verifies a thermal trip. Shut down power and allow to cool. Verify connector is seated
	Flow rate is too high	A14	Check LOAD PCT for 100% load	Reduce flow rate, heater is operating outside of capability	A15
	Element failure	A15	Power off, Using a multimeter check continuity at between red and black wires at each element chamber	16	No continuity- replace heater element. Check water quality
	Heating Elements not modulating	A16	Verify SSR/Triac functionality by checking current draw off each SSR/Triac by means of an amp clamp. Also verify signal wires are connected from PCB P2, P3, and P4		No current draw- replace SSR/ Triac
Display FAULT F2	Ambient light is causing the optical (overheat) sensors to trip.	A17	Unit is to be operated with the cover on or (if NEMA equipped) door closed when power is applied to the unit.	A18	Close door, or reinstall cover
	Air is present in the heating chamber	A18	Verify air is not present in the system by checking for a red led light on the heating chamber. Look between the black manifolds into the clear tube sections for air bubbles.	Remove air by installing an air scrubber prior to heater, or flushing system thoroughly before use. Check all wire connections	Replace light sensor board
	Loose /cut wire to optical sensors	A19	Verify 5VDC is present on the last optical sensor in the chain by using a multimeter set for dc voltage at the connector P12 with one meter lead on the red wire and the other on the black wire.	Check A17 and A18 again	Call Haws for support
Display FAULT F3	Multiple dry fire conditions detected (FAULT F2) more than 3 times	A20	Recheck actions A17-A19. Shut down power and restart		Replace main PCB and light sensor boards
Display FAULT F4	Inlet thermistor out of range	A21	Verify inlet thermistor is properly seated in thermal well	Verify inlet temperature is not below freezing, above set point temperature, or heater is piped backwards	Replace thermistor inlet or outlet or both
No Heat	Turn-on flow rate not satisfied	A22	Toggle through display to verify FLOWRATE and TURN-ON	Increase water flow rate above TURN-ON setting	Check wiring to flowmeter
	Display states FLOW ???	A23	Power off unit, and verify no faults are found. Verify flow meter harness is seated in terminal P12 on the main PCB and at flow meter PCB	Call Haws for support, firmware reload may be required	If faults found reference above

Note: Error code history is not self-clearing. Unit keeps track of past errors. Error codes do not necessarily mean there is a current error.

TECHNICAL SUPPORT

TECHNICAL SUPPORT FORM -- Perform steps below before calling Haws services

Water Heater Model No. _____ Serial No. _____

Inlet Water Pressure _____ Inlet Water Temperature _____

INCOMING VOLTAGE TESTING ELEMENTS

INCOMING ELEMENTS



L1 _____
L2 _____
L3 _____

TESTING ELEMENTS



Amp draw on each heating element, place clamp on each red wire on inlet side of contactor.

E1 _____ E4 _____
E2 _____ E5 _____
E3 _____ E6 _____

Ohm out heating elements: place #1 lead on 1 terminal on right side of SSR (FIG 1); place #2 lead (FIG 2) on the matching numbered red wire on outlet side of contactor.

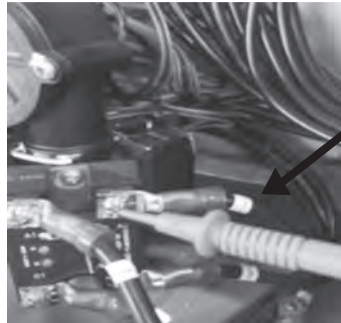

Fig 1

Wire #1 TAG

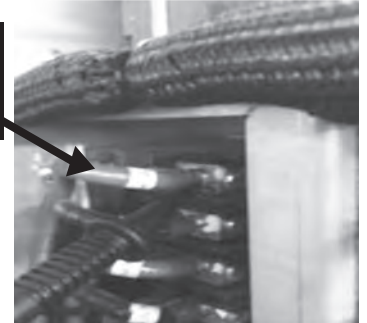
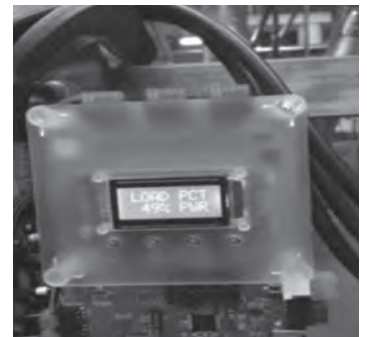

Fig 2



GPM FLOW RATE _____



LOAD PERCENTAGE _____

TESTING POINTS

TESTING OPTICAL SENSORS

Ohm out optical sensors: find jack plug p5 on circuit board and place #1 lead on the blue wire, then place #2 lead on the on the blue wire on the back right optical board. Move #2 lead to each blue wire on optical boards to verify continuity. Repeat with black wire.

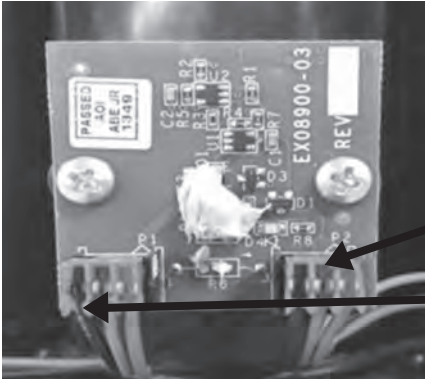

LEAD PLACEMENT:

Test blue and black separately. Put 1 lead on blue wire on P5 plug then other lead goes to each blue wire along optical sensors. Repeat with black wire.

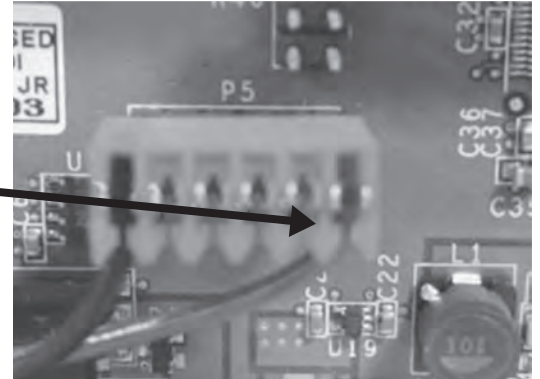

TEST ECO'S (ELECTRIC CUT OFFS):

To check ECO'S, on jack plug P17 put leads between top and bottom contact. If no continuity, then check across each ECO

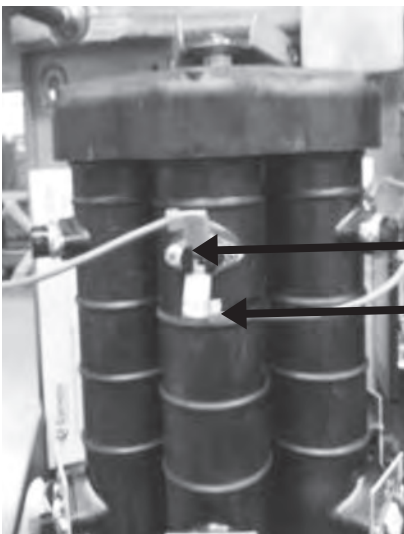

Test points for individual ECO

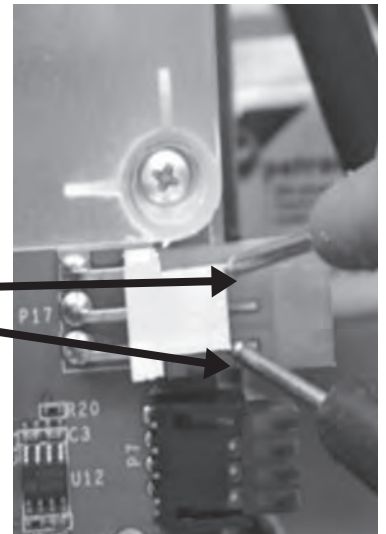

Test points to check all ECOs

CONFIGURATION PARAMETERS LOADING GUIDE

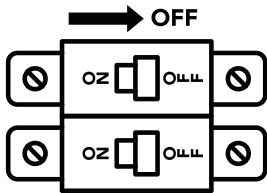

Record and document any error codes on display, as inserting USB will erase all code history. Then disconnect power from the heater by turning off the circuit breaker.

ERROR CODES:

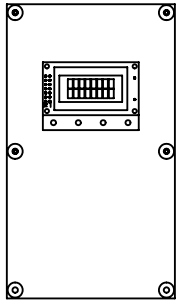

For the units with the Standard cabinet, remove the 5 mounting screws to remove the cover.

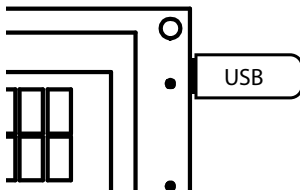

Plug in the USB

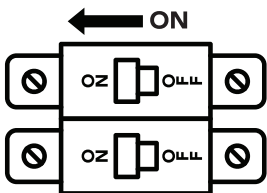

Turn on the power

ACTUAL
TEMP 73F

Home screen will appear first

USB CONN
90 73F

The heater has recognized the USB drive

USB CONN
CNF READ

CNF file has been successfully loaded. If "CNF ERR" is displayed, try removing reseating the USB into the slot

USB CONN
90 73F

It is now OK to turn off the power, remove the USB, and replace the cover

REPAIRS AND OPTIONS



WARNING

Service and repairs are to be performed by licensed electricians or qualified servicemen.



WARNING

Before attempting any repairs to the heater, make sure that the electrical breaker is "off" and confirm that there is no voltage at the heater.

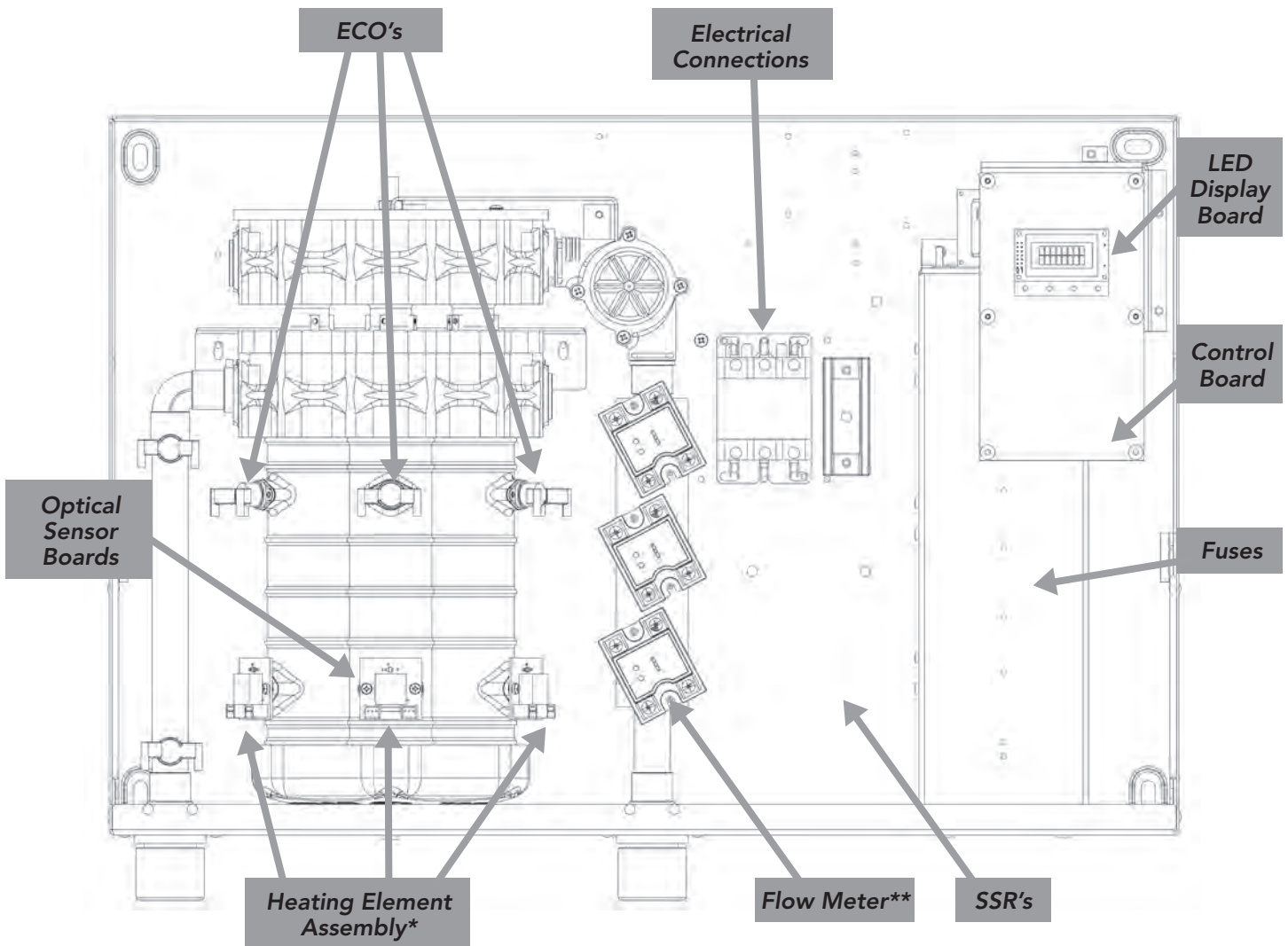

* HEATING ELEMENT ASSEMBLY CONSISTS OF ONE HEATER CORE AND WIRE ELEMENT(S)

** FLOW METER KIT CONSISTS OF PADDLE WHEEL, DOWEL PIN, O RING AND 4 MOUNTING SCREWS

NEMA CABINET 4, 4X, 4X (316)

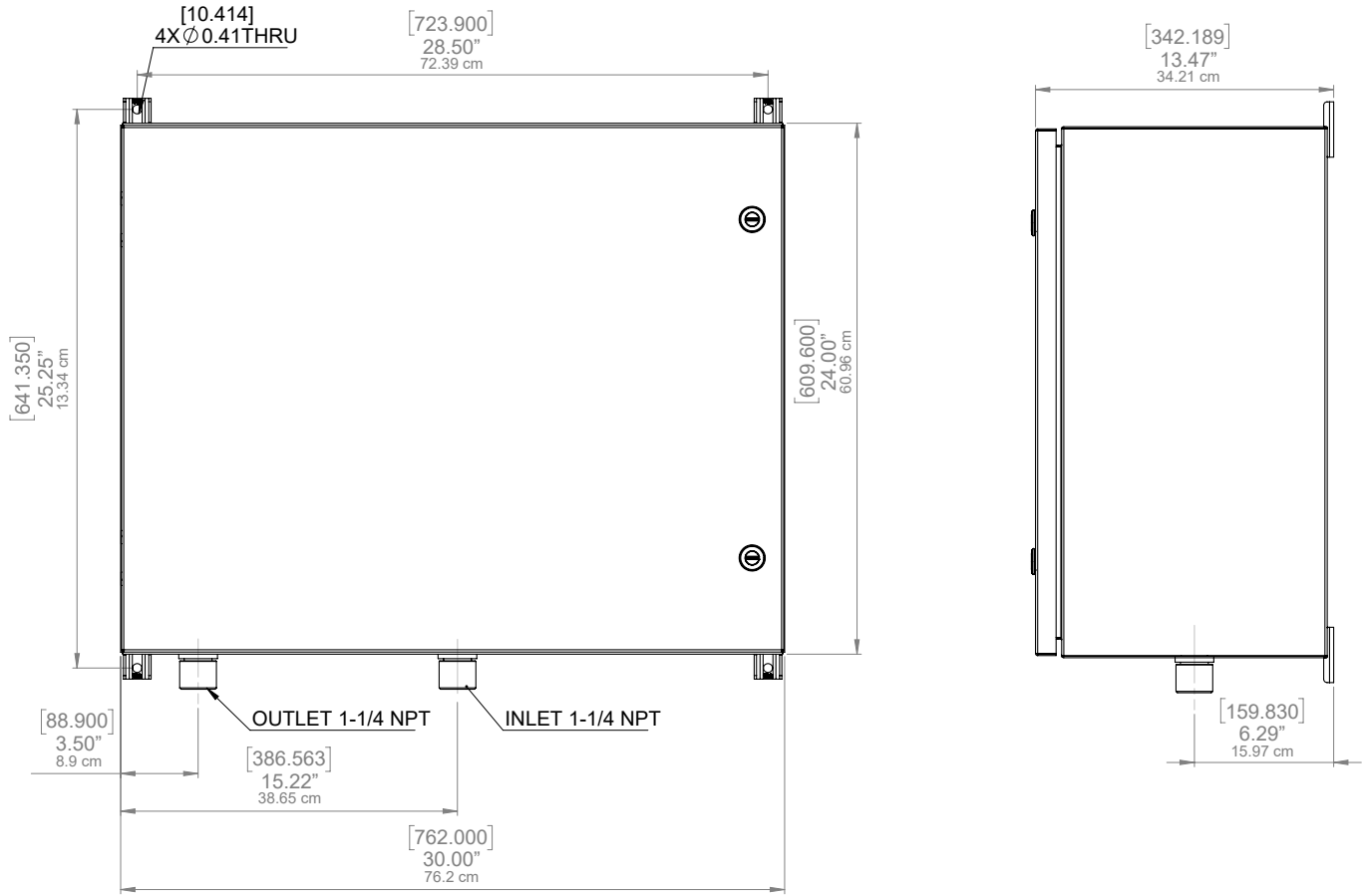

NON-WATERPROOF CABINET

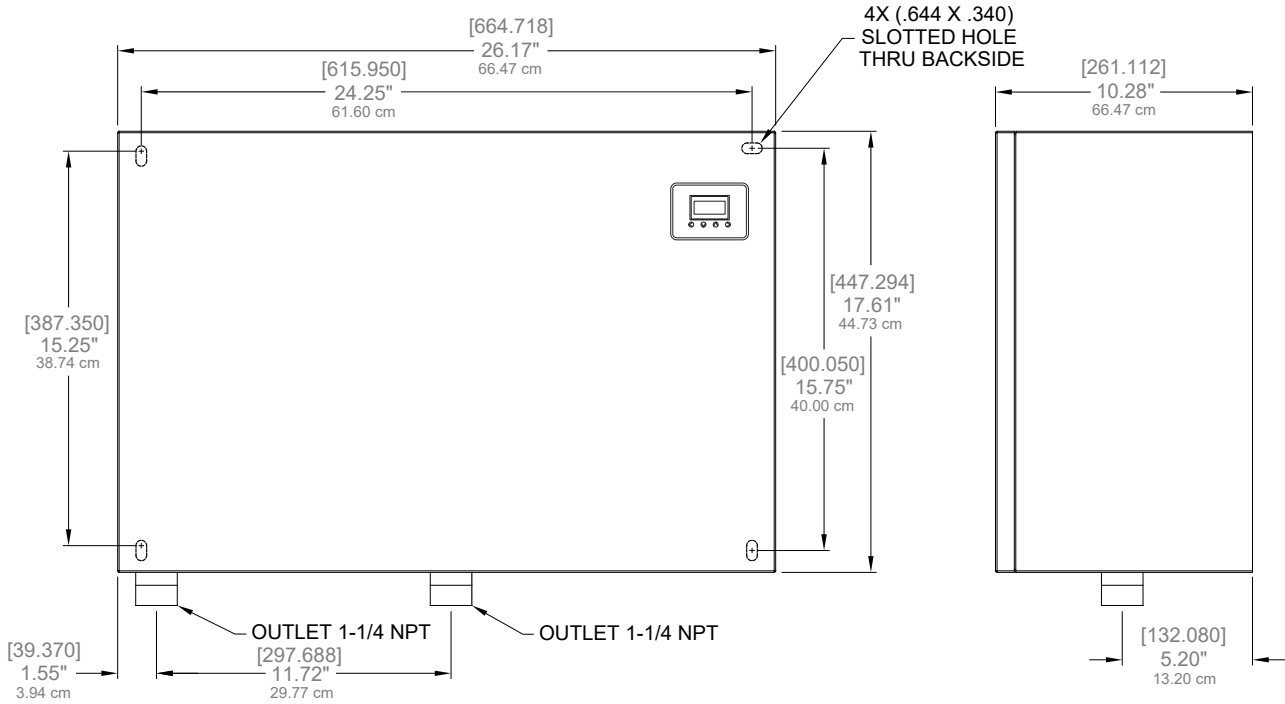

OPTIONAL ENCLOSURE HEATER

- 1) Attach heat tape and foam insulation to all lengths of inlet and outlet water piping that are exposed to freezing temperature. We recommend a rating of -30 degrees F at 10 miles per hour wind. Connect the heat tape to an independent source of electrical power.



CAUTION

Failure to attached heat tape and insulation to exposed inlet and outlet pipes will **void the warranty**.

- 2) Set the thermostat on the enclosure heater, located at the upper left corner in the enclosure, to 40 – 70 degrees F.

Note: Heater fan continuously operates to recirculate air in the enclosure. The heater coil will activate based on thermostat set point



Note: Power must be applied to the water heater for the freeze protection system to operate. If power is not applied ensure the system is completely drained. Neglecting to do so will damage the heater and void the warranty.

OPTIONAL GFCI

The optional GFCI consist of **(A) Control Module** and **(B) Current Transformer**. This control module has a LCD display indicating real-time measurements. The GFCI module is preset from factory to trip at 3.0 A.

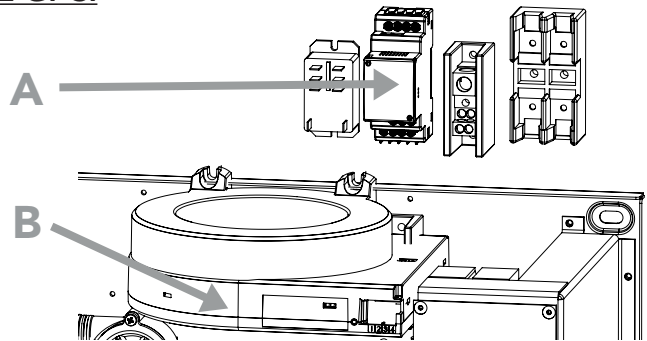

Test and reset functions are carried out automatically every 24 hours. To manual test the GFCI, press the test button for a minimum of 1.5 seconds. To reset a tripped GFCI, cycle the power of the unit. If equipped with a disconnect handle, turn the handle to the **"OFF"** position then back to **"ON"**.

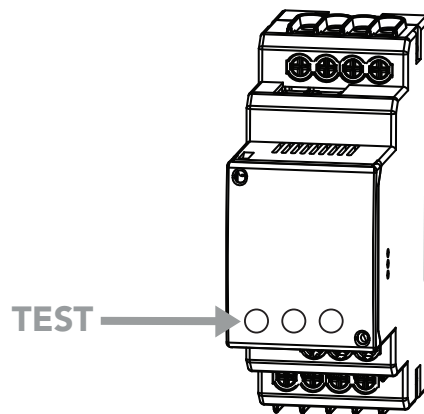

OPTIONAL NON-FUSIBLE DISCONNECT SWITCH

DISCONNECT SWITCH MODEL	60 A	100A	200 A
Operating Voltage	600V	600V	600V
Max Horsepower Rating:			
120 VAC 1-Phase	3	-	-
220/240 VAC 1-Phase	10	10	10
220/240 VAC 3-Phase	20	30	75
400/440/480 VAC 3-Phase	40	75	150
600 VAC 3=Phase	50	100	200
Short circuit rating with fuses	100	200	200
Branch circuit fuse type	J	J	J
Max fuse rating (A)	60	100	200

Disconnect Handle

NEMA Type: 4, 4X | Color: Red/Yellow

OPTIONAL FUSIBLE DISCONNECT SWITCH

DISCONNECT SWITCH MODEL	200 AMP	100 AMP
RATING (A)	600V	600V
Max horsepower rating/ Max motor FLA current phase Three		-
208 v	50/150	25/78.5
240 v	60/154	30/80
400/480 v	125/156	60/77
600 v	130/144	75/77
DC 125 V (2 pole in series)	15/112	7.5/58
DC 250 V (3 pole in series)	40/140	20/38
Short circuit rating with fuses	200	200
Branch circuit fuse type	J	J
Max fuse rating (A)	200	100

- NOTES:
- ITEMS SHOWN DASHED (IN BOX) ARE SHOWN FOR REFERENCE ONLY AND ARE NOT SUPPLIED. MANUFACTURER REQUIRES ALL COMPONENTS TO PROTECT UNIT, AND PROVIDE FUTURE SERVICEABILITY. INTERCONNECTING PIPING TO BE 1-1/4" IPS.
 - REFER TO OWNER'S MANUAL FOR INSTALLATION INSTRUCTIONS
 - DESIGNED FOR WALL MOUNTED INSTALLATION

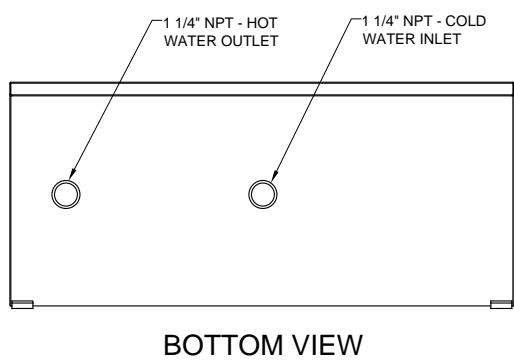

BOTTOM VIEW

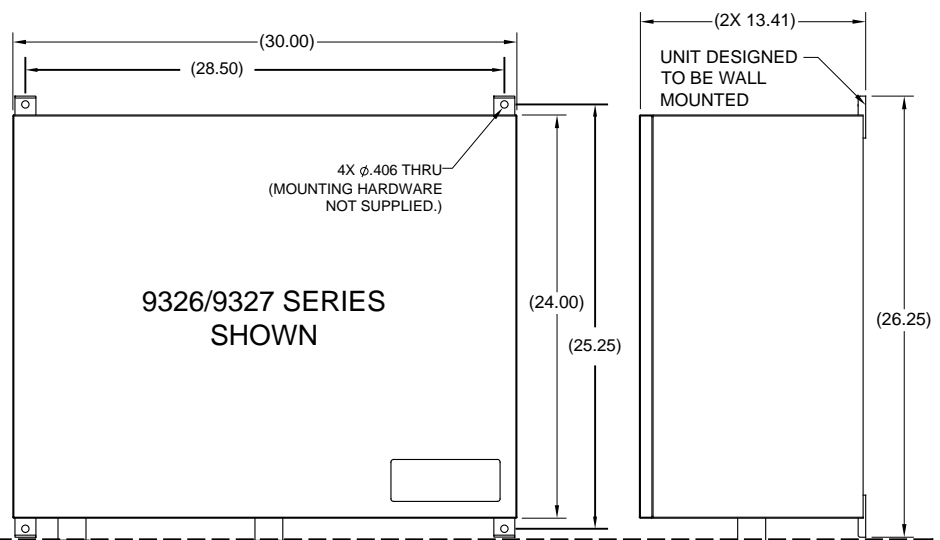

9326/9327 SERIES SHOWN

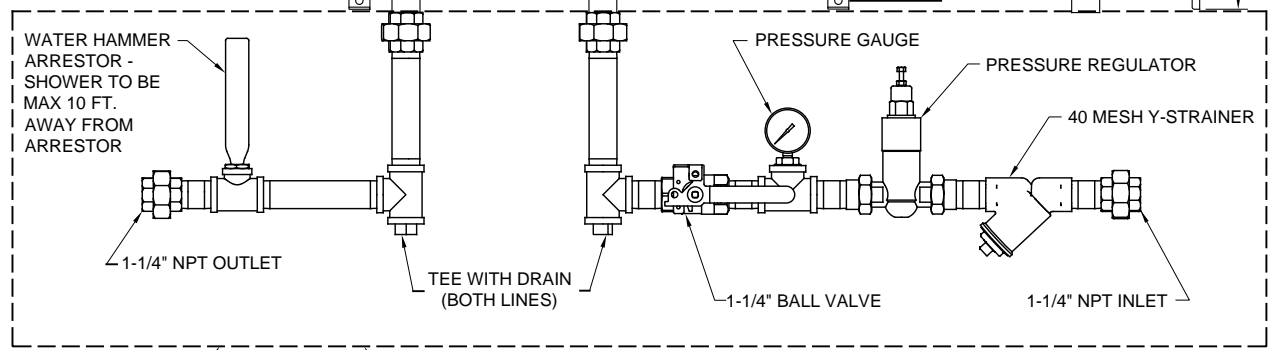

1 REQUIRED PIPING LAYOUT (NOT SUPPLIED): AVAILABLE AS HAWS HEATER PIPING KIT MODEL 932X. INTERCONNECTING PIPING TO BE 1-1/4" IPS.

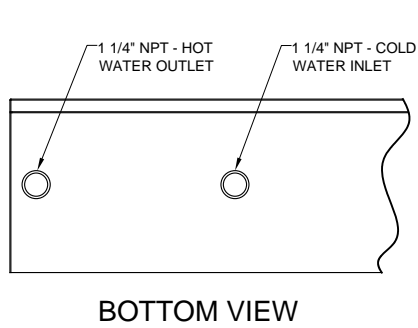

BOTTOM VIEW

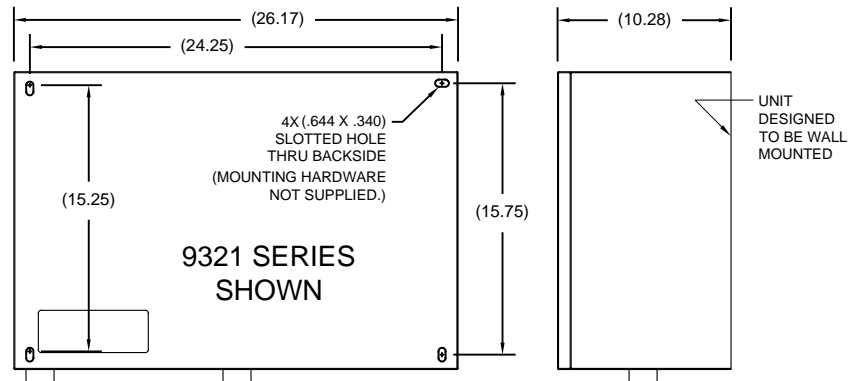

9321 SERIES SHOWN

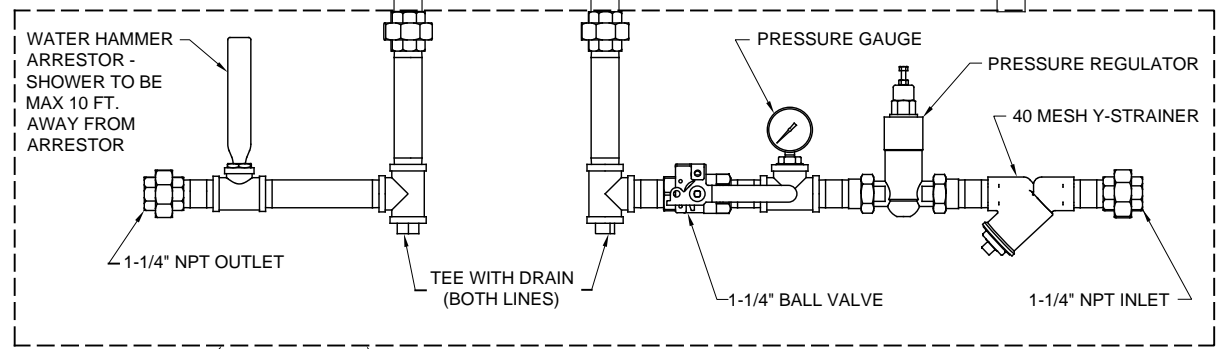

1 REQUIRED PIPING LAYOUT (NOT SUPPLIED): AVAILABLE AS HAWS HEATER PIPING KIT MODEL 932X. INTERCONNECTING PIPING TO BE 1-1/4" IPS.

	ECN NO. REVISED PER BY:	MODEL(S)
	5318 ECN.5970 F.V.	9321/9321CE/9326/9326CE/9327/9327CE
	DATE: 1-30-14	
	CHKD:	
APPROVED:	SCALE: N/A	DRAWING TYPE: INSTALLATION
1456 KLEPPE LANE SPARKS, NEVADA 89431 (775) 359-4712 FAX (775) 359-7424 E-MAIL: HAWS@HAWSCO.COM WEBSITE: WWW.HAWSCO.COM		
PART NUMBER 0002080089.D		
REVISION: 5		
06/23		

WIRING SCHEMATICS

MODEL	HEATER ELEMENT DATA			TOTAL		FUSE
	VOLTS	K-WATTS	AMPS	K-WATTS	AMPS	
AP054480	480	18	37.5	54	65	40

NOTE: ALL WIRE IS UL 1015, 105°C, 600V RATED

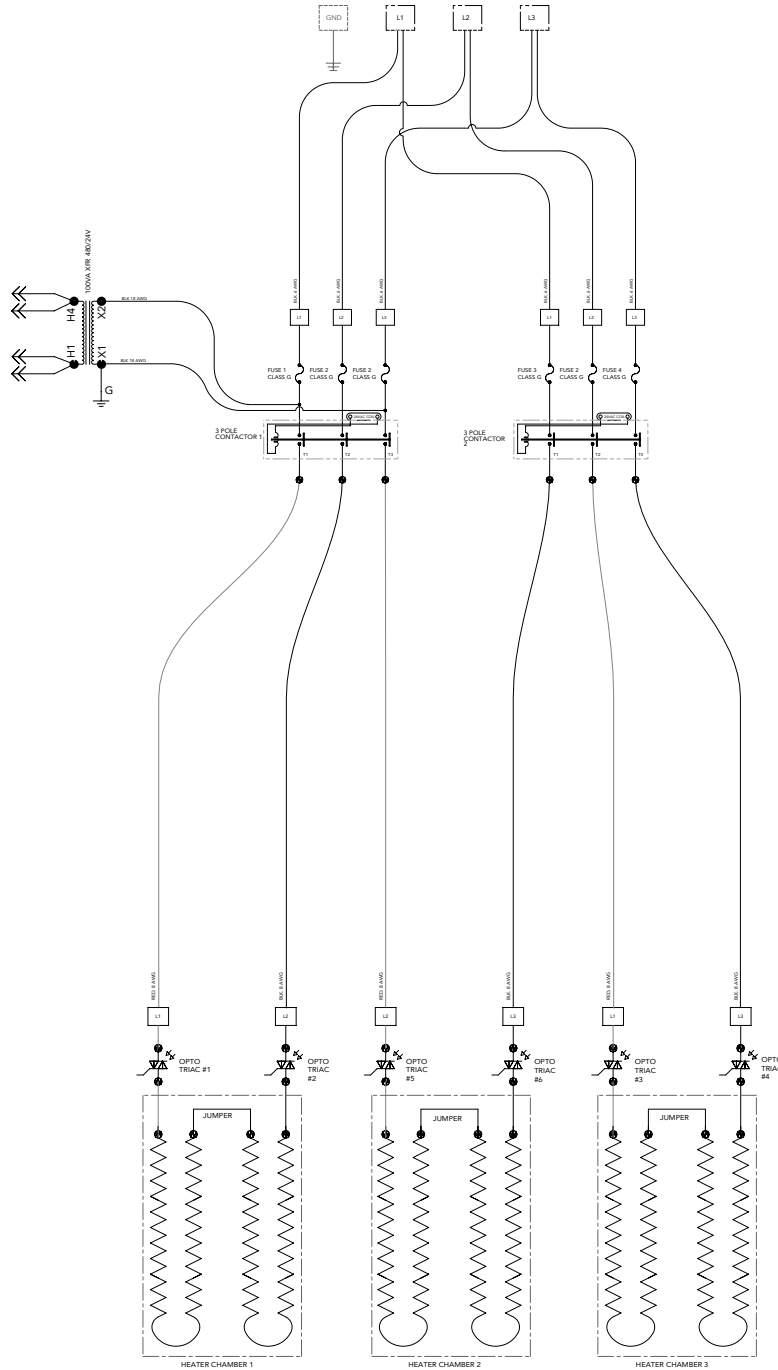

MODEL	HEATER ELEMENT DATA			TOTAL		FUSE
	VOLTS	K-WATTS	AMPS	K-WATTS	AMPS	
AP050400	400	8.3	20.8	50	73	30
AP063480	480	10.5	21.9	63	76	50
AP072480	480	12	25	72	86	50

NOTE: ALL WIRE IS UL 1015, 105°C, 600V RATED

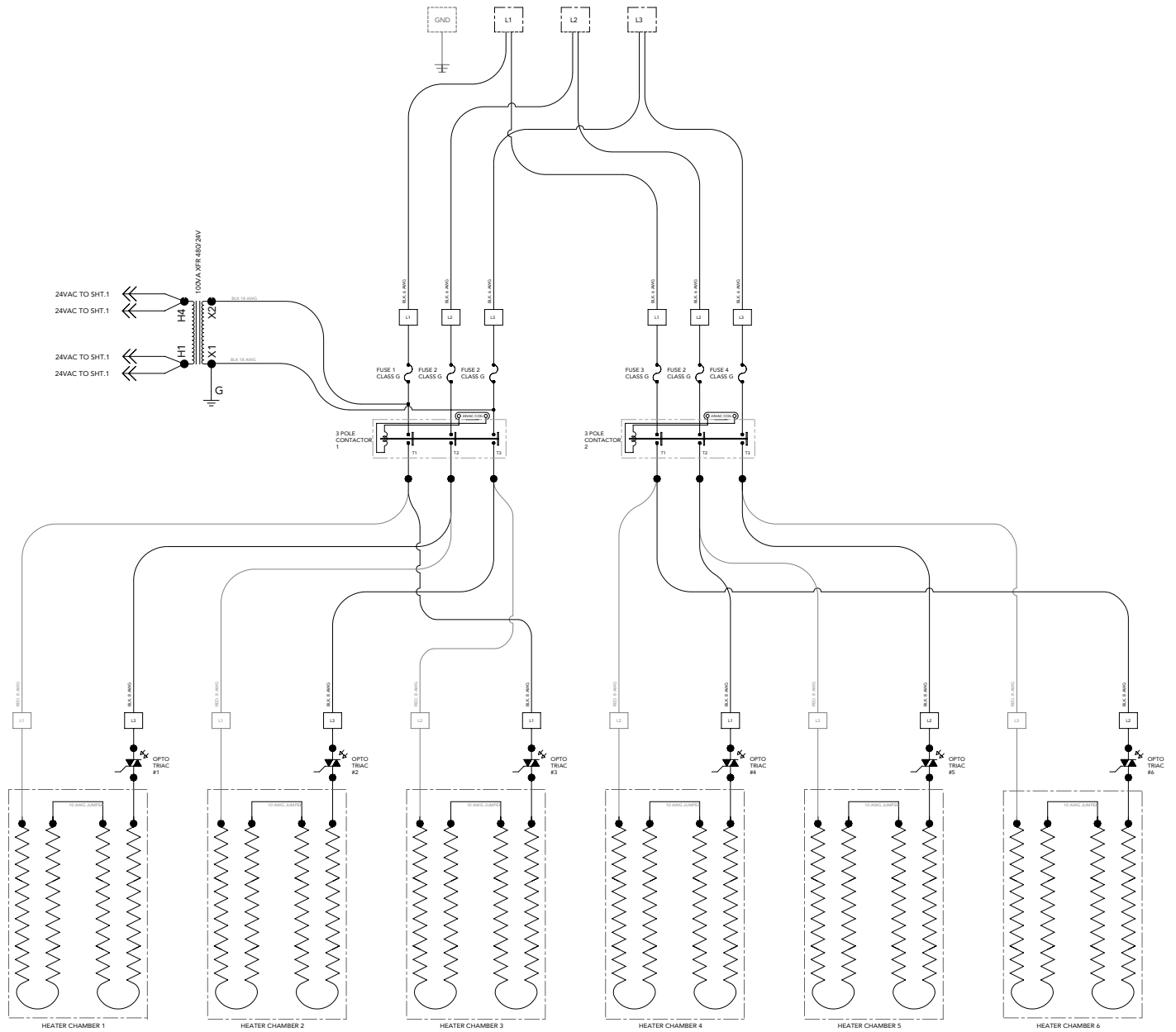

MODEL	HEATER ELEMENT DATA			TOTAL		FUSE
	VALUES PER MODULE			K-WATTS	AMPS	
	VOLTS	K-WATTS	AMPS			
AP064208	208	10.6	51.3	64	178	60
AP096480	480	16	33.3	96	116	50
AP108480	480	18	37.5	108	130	50
AP075400	400	12.5	31.3	75	109	50
AP126480	480	21	43.8	126	152	60
AP144480	480	24	50	144	173	60
AP100400	400	16.7	41.7	100	145	60
AP102600	600	17	28.3	102	99	60
AP130600	600	21.6	36.1	130	126	60
AP150600	600	25	41.7	150	145	60
AP120400	400	20	50	120	174	60

NOTE: ALL WIRE IS UL 1015, 105°C, 600V RATED

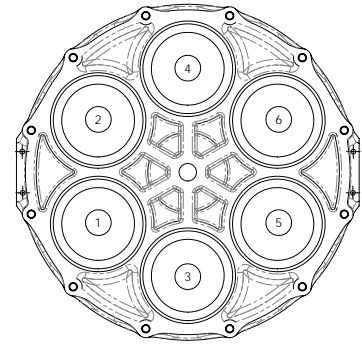

Heating Chamber Numbering

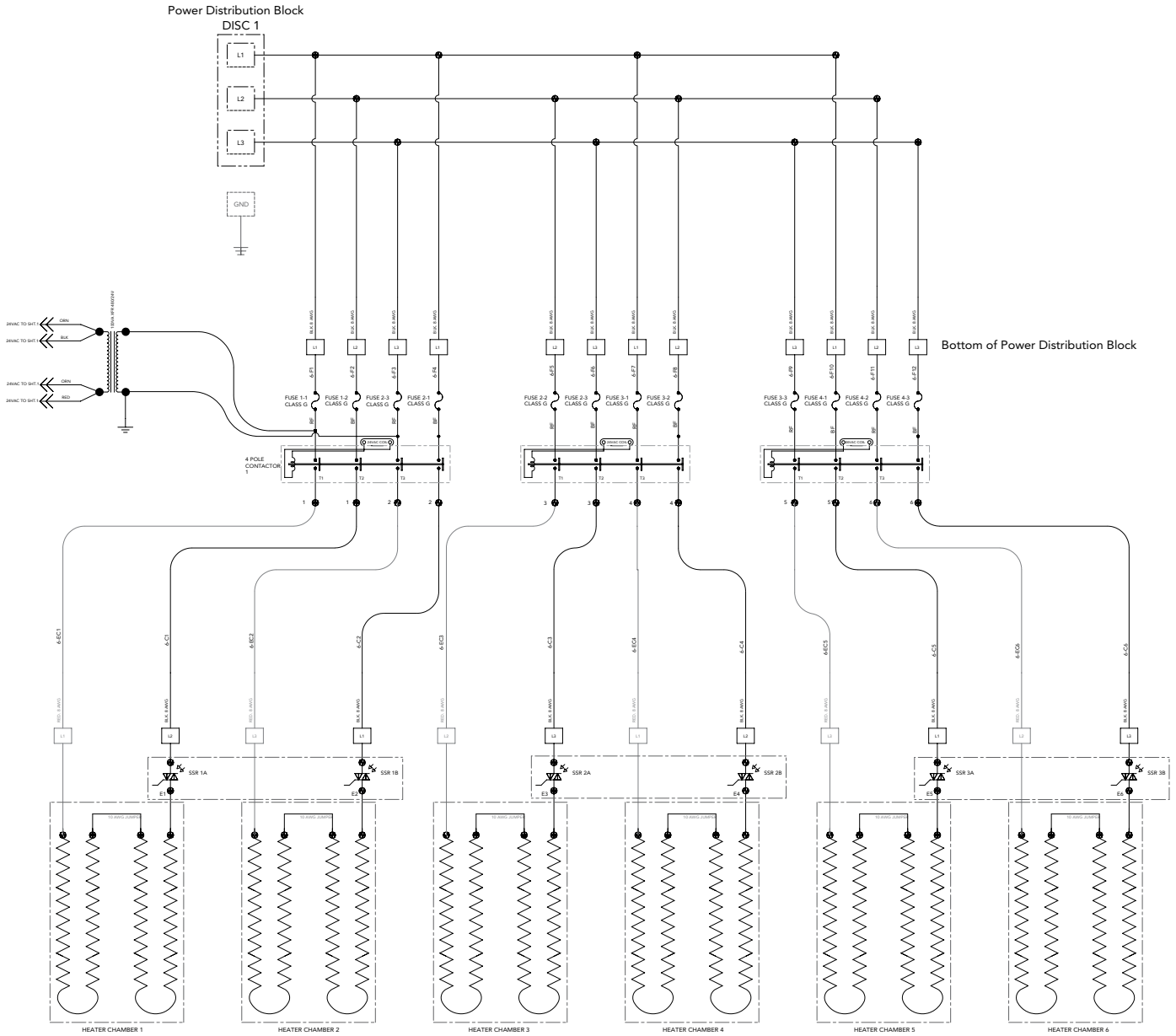

HAWS ELECTRIC TANKLESS WATER HEATERS LIMITED WARRANTY



PLEASE LEAVE THIS WARRANTY WITH OWNER

Subject to the terms and conditions set forth in this limited warranty, each HAWS Tankless Water Heater is warranted to the original owner ("Owner") against (i) mechanical or electrical failure of any component solely due to defects in materials or Manufacturer's workmanship for a period of one year from the date of original purchase and (ii) leaks solely due to defects in materials or Manufacturer's workmanship for the later of (x) five years from the date of original purchase or (y) the date of Owner's occupancy of a new dwelling in which the HAWS Tankless Water Heater is installed. However, if Owner cannot document the original date of purchase with the original sales receipt, then the limited warranty period begins on the date the HAWS Tankless Water Heater was manufactured. As Owner's sole and exclusive remedy, Manufacturer shall, at Manufacturer's sole election, either repair or replace the HAWS Tankless Water Heater or the defective portion of such product. Manufacturer is not liable for any costs incurred by Owner, including, without limitation, the cost of any labor. Manufacturer's maximum liability is limited to the value of the water heater. This limited warranty shall be governed by the laws of the United States.

THIS LIMITED WARRANTY SHALL BE THE EXCLUSIVE WARRANTY MADE BY MANUFACTURER AND IS MADE IN LIEU OF ALL OTHER WARRANTIES, STATUTORY, EXPRESSED OR IMPLIED (WHETHER WRITTEN OR ORAL), INCLUDING, BUT NOT LIMITED TO, WARRANTIES OF MERCHANTABILITY AND FITNESS FOR A PARTICULAR PURPOSE. MANUFACTURER EXPRESSLY DISCLAIMS THE IMPLIED WARRANTIES OF MERCHANTABILITY AND FITNESS FOR A PARTICULAR PURPOSE. OWNER'S SOLE AND EXCLUSIVE REMEDY IS PRODUCT REPAIR OR REPLACED, AS PROVIDED IN THIS LIMITED WARRANTY, AND ALL OTHER CLAIMS FOR DAMAGES ARE EXCLUDED.

THE REMEDIES SET FORTH IN THIS LIMITED WARRANTY ARE THE ONLY REMEDIES AVAILABLE TO OWNER OR ANY PERSON FOR BREACH OF ANY COVENANT, DUTY OR OBLIGATION ON THE PART OF MANUFACTURER. MANUFACTURER IS NOT LIABLE TO OWNER OR ANY THIRD PARTY FOR ANY LOSS, PERSONAL INJURY OR PROPERTY DAMAGE, DIRECTLY OR INDIRECTLY, ARISING FROM THE HAWS TANKLESS WATER HEATER. UNDER NO CIRCUMSTANCES IS MANUFACTURER LIABLE TO OWNER OR ANY THIRD PARTY FOR INCIDENTAL, CONSEQUENTIAL, SPECIAL, CONTINGENT, OR PUNITIVE DAMAGES OF ANY DESCRIPTION, WHETHER ANY SUCH CLAIM BE BASED UPON WARRANTY, CONTRACT, NEGLIGENCE, STRICT LIABILITY, OR OTHER TORT, OR OTHERWISE. SOME STATES DO NOT ALLOW THE EXCLUSION OR LIMITATION OF INCIDENTAL OR CONSEQUENTIAL DAMAGES, SO THE ABOVE LIMITATION OR EXCLUSION MAY NOT APPLY TO OWNER. IN SUCH CASES, THE WARRANTY SHALL BE LIMITED TO ONE YEAR FROM THE ORIGINAL DATE OF PURCHASE OR DATE OF MANUFACTURE, AS PROVIDED IN THIS LIMITED WARRANTY, OR THE SHORTEST PERIOD ALLOWED BY LAW. THIS WARRANTY GIVES OWNER SPECIFIC LEGAL RIGHTS AND OWNER MAY ALSO HAVE OTHER RIGHTS WHICH MAY VARY FROM STATE TO STATE.

HAWS ELECTRIC TANKLESS WATER HEATERS LIMITED WARRANTY

Exclusions of Coverage from this Limited Warranty:

1. Manufacturer is not liable for any water damage or other damages arising, directly or indirectly, from any defect in the HAWS Tankless Water Heater component part(s) or from its use.
2. Manufacturer is not liable under this limited warranty or otherwise if:
 - a. The water heater or any of its component parts have been subject to misuse, alteration, neglect or accident; or
 - b. The water heater has not been installed in accordance with the applicable local plumbing and/or building code(s) and/or regulation(s); or
 - c. The water heater has not been installed or maintained in accordance with Manufacturer's printed instructions, or installed with improper orientation, improper fastening, improper use of pipe dope/plumbers putty or with the use of any non Manufacturer approved sealant; or
 - d. The water heater has not been continuously supplied with potable water or the water's inlet temperature is above Manufacturer's recommended maximum temperature; or
 - e. The water heater experiences any water pressure or flow interruptions, normal inlet water pressure is outside of the published specification for the heater; is exposed to any condition that causes the heater to turn on before the air is purged from the heater also know as dry fire; or
 - f. The water heater has been exposed to conditions resulting from floods, earthquakes, winds, fire, freezing, lightning, or circumstances beyond the Manufacturer's control; or
 - g. The water heater has been removed from its original installation location; or
 - h. The water heater has been used for other than the intended purpose.
3. Owner, and not Manufacturer or its agent/representative, is liable for and shall pay for all field charges for labor or other expenses incurred in the removal and/or repair of the water heater or any expense incurred by Owner in order to repair the water heater.

Subject to the terms and conditions set forth in this limited warranty, if the HAWS Tankless Water Heater fails or leaks because of defects in materials or Manufacturer's workmanship during the applicable warranty period set forth above, Owner should contact Manufacturer for a Returned Merchandise Authorization (RMA). No returns will be accepted by Manufacturer without an RMA number and Manufacturer assumes no responsibility for a water heater returned without an RMA number. Water heaters should be wrapped and packaged securely to avoid shipping damage. All shipments of parts from the Manufacturer to the Owner to replace defective components shall be made via normal ground transportation. If expedited shipment is required, it will be provided at Owner's additional cost.





Haws Corporation
1455 Kleppe Lane, Sparks, NV 89431
+1-775-359-4712 Fax: (775) 359-7424
info@hawsco.com
www.hawsco.com

Haws - EMEA
P: + 41(0)34 420 60 00
www.Haws.ch